

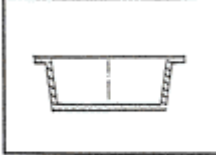







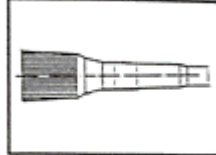
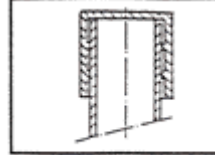
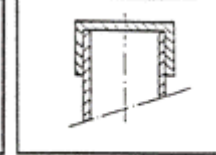
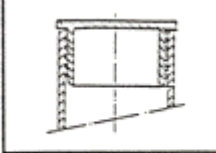
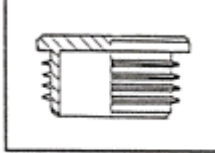
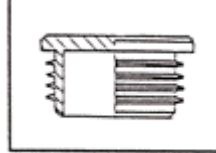
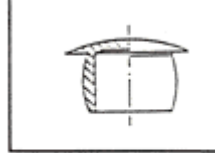
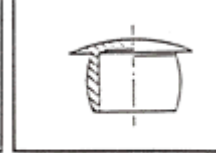
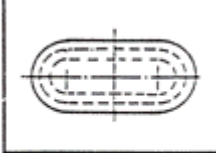

Kunststoffverarbeitung und Fertigung von Baugruppen

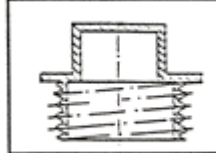
Programmübersicht Schutzelemente aus Kunststoff

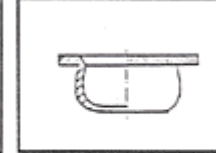
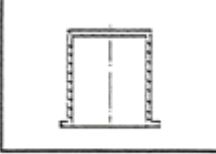
Stand März 2011

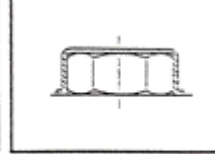
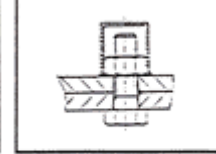
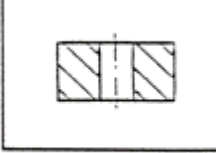
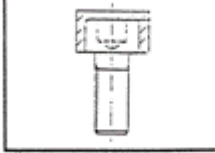
LAWAL-Schutzelemente Übersicht

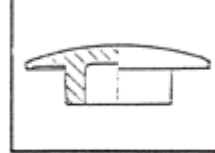
				
Universal-Schutzstopf. LAW 1000	Rundkappen LAW 1200	Einschraubelemente LAW 1250	Rohrschutzkappen LAW 1300	Vierkantkappen LAW 1350
				
Vierkantstopfen LAW 1400	Lamellenstopfen LAW 1450	Lamellenstopfen LAW 1460	Endkappen LAW 1500	Endkappen LAW 1510
				
Stopfen f. Ovalrohr LAW 1600	Stopfen m. Griffrand LAW 1700	Schraubstopfen Zoll LAW 1800	Stopfen zylindrisch LAW 1850	Senkstopf. m. Rändel LAW 2000
				
Schutzhülsen lang LAW 2100	Kappen Schmiernippel LAW 2150	Sechskantkappen LAW 2200	Sechskantkappen LAW 2250	Klemmkappen Sechsk. LAW 2260
				
Distanzscheiben LAW 2300	Überzugkappen Inbus LAW 2400	Kappen Inbus groß LAW 2500	Zierkappen Inbus LAW 2600	

LAWAL-Schutzelemente – Kurzinformation

Preise und Lieferbedingungen

I. Preise

Die Preise sind Nettopreise zuzüglich der jeweils gültigen Mehrwertsteuer, ab Werk Langenau (DDU Langenau)

II. Rabatte

Jeweils geschlossene Abnahme pro Produkt in einer Sendung

- ab 5.000 Stück = 15% Rabatt
- ab 10.000 Stück = 20% Rabatt
- ab 20.000 Stück = 22% Rabatt
- ab 30.000 Stück = 24% Rabatt
- ab 50.000 Stück = 25% Rabatt

III. Kleinmengen

Pro Position müssen mindestens 50,00 € erreicht werden. Der Mindestwarewert pro Bestellung beträgt 100,00 €.

V. Zahlung

Per Rechnung mit 2% Skonto innerhalb von 10 Tagen oder rein netto innerhalb 30 Tagen.

Die Ware bleibt bis zur vollständigen Bezahlung unser Eigentum.

LAWAL-Schutzelemente – Kurzinformation

Materialkenndaten

Farben	weiß	ähnlich RAL 9010
	creme	ähnlich RAL 9001
	grau	ähnlich RAL 7035
	schwarz	ähnlich RAL 9005
	gelb	ähnlich RAL 1018
	rot	ähnlich RAL 3000

Bedingt durch die Eigenfarbe des Kunststoffes ergeben sich Abweichungen

Material

		Temperaturbeständigkeit		Lichtdurchlässigkeit		
		kurz	dauernd	durchscheinend	transparent	opak
ABS	Acrylnitril-But.-Styrol	90° C	80° C	○	○	○
LDPE	PE weich	60° C	40° C	○	○	○
HDPE	PE hart	100° C	80° C	○	○	○
PP	Polypropylen	130° C	100° C			○
PA6	Polyamid 6	150° C	90° C			○

Chemikalienbeständigkeit

Medium	LDPE	HDPE	PP	PA6
Alkohol	X	X	X	
Fette	X	X	X	X
Fluss-Säure	X	X	X	
Laugen nicht oxydierende	X	X	X	X
Lösemittel	X	X	X	X
Öle	X	X	X	X
Säuren nicht oxydierende	X	X	X	X
Treibstoffe	X	X	X	X

Recycling

Die vorwiegend verwendeten Materialien PE (Polyäthylen) und PP (Polypropylen) sind voll recyclingfähig. Sie eignen sich auch gut zur thermischen Verwertung.

Universal-Schutzstopfen LAW 1000

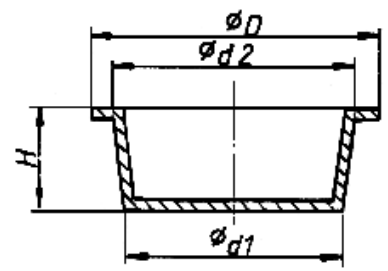

- für Rohre innen
- für Innengewinde

Material: PE-weich
Standardfarbe: creme

d1/mm	d2/mm	D/mm	H/mm	CO-Nr.	Artikel- Nummer	Preis pro 1000 Stück
4,50	6,25	10	10	1	10-1001	29,40 €
6,00	7,75	12	10	2	10-1002	29,40 €
7,50	9,25	14	10	3	10-1003	29,40 €
8,50	10,25	15	10	4	10-1004	29,40 €
9,25	11,00	15	10	5	10-1005	29,40 €
10,00	11,75	15	10	6	10-1006	30,10 €
11,50	12,75	17	10	7	10-1007	30,10 €
12,75	14,50	18	10	8	10-1008	30,10 €
14,00	15,75	20	10	9	10-1009	30,10 €
15,25	17,00	21	10	10	10-1010	30,10 €
16,50	18,25	22	10	11	10-1011	30,70 €
17,75	19,50	24	10	12	10-1012	30,70 €
19,00	20,75	25	10	13	10-1013	30,70 €
20,25	22,00	26	10	14	10-1014	32,00 €
21,25	23,25	27	10	15	10-1015	32,00 €
22,75	24,50	28	10	16	10-1016	32,00 €
24,00	25,75	29	10	17	10-1017	32,00 €
25,25	27,00	31	10	18	10-1018	32,00 €
26,50	28,25	33	10	19	10-1019	32,00 €
28,00	30,50	35	15	20	10-1020	62,70 €
30,00	32,20	36	15	21	10-1021	62,70 €
32,00	34,50	38	15	22	10-1022	62,70 €
34,00	36,50	40	15	23	10-1023	62,70 €
36,00	38,50	42	15	24	10-1024	69,00 €
38,00	40,50	44	15	25	10-1025	69,00 €
40,00	42,00	46	15	26	10-1026	69,00 €
41,50	44,00	48	15	27	10-1027	90,80 €
44,00	46,50	50	15	28	10-1028	90,80 €
46,00	48,70	53	15	29	10-1029	97,30 €
49,00	51,50	55	18	30	10-1030	97,30 €
51,00	53,50	58	17	31	10-1031	104,80 €
54,00	57,00	61	17	32	10-1032	104,80 €

Alle Preise zzgl. MWSt., Stand 01/2009
Bitte beachten Sie unsere Rabattstaffeln

Universal-Schutzstopfen LAW 1000

Fortsetzung

d1/mm	d2/mm	D/mm	H/mm	CO-Nr.	Artikel- Nummer	Preis pro 1000 Stück
57,00	59,50	64	17	33	10-1033	167,50 €
59,50	62,50	66	17	34	10-1034	167,50 €
61,00	64,00	68	17	35	10-1035	172,60 €
64,50	67,00	71	17	36	10-1036	221,80 €
68,50	71,00	75	17	37	10-1037	221,80 €
70,50	73,00	77	17	38	10-1038	274,90 €
73,00	75,50	80	17	39	10-1039	274,90 €
75,50	78,00	82	17	40	10-1040	274,90 €
78,00	81,00	86	17	41	10-1041	274,90 €
80,00	84,00	88	17	42	10-1042	302,90 €
83,50	87,00	92	19	43	10-1043	302,90 €
86,50	89,50	94	19	44	10-1044	302,90 €
89,00	93,00	97	19	45	10-1045	333,60 €
92,00	96,00	99	19	46	10-1046	345,80 €
96,00	98,00	103	19	47	10-1047	361,10 €

Alle Preise zzgl. MWSt., Stand 01/2009
Bitte beachten Sie unsere Rabattstaffeln

Rundkappen LAW 1200

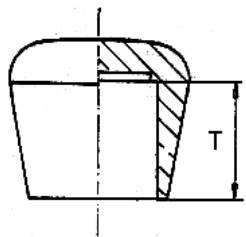

- für Rohre außen
- für Außengewinde

Material: PE-weich
Standardfarbe: schwarz

Rohrdurchmesser in mm	Einstecktiefe T/mm	CO-Nr.	Artikelnummer	Preis pro 1000 Stück
2,9	7,9	550	12-1203	33,10 €
3,9	8,0	552	12-1204	33,10 €
5,0	6,7	554	12-1205	35,40 €
5,9	9,5	556	12-1206	35,40 €
6,9	8,0	558	12-1207	37,70 €
7,9	11,4	560	12-1208	41,10 €
9,7	12,1	562	12-1210	44,50 €
10,9	13,2	564	12-1211	47,90 €
11,9	12,9	566	12-1212	53,60 €
13,0	12,0	568	12-1213	53,60 €
13,7	13,2	570	12-1214	58,90 €
15,0	16,0	572	12-1215	58,90 €
15,9	17,0	574	12-1216	58,90 €
17,8	19,0	576	12-1218	58,90 €
18,8	19,2	578	12-1219	69,60 €
20,0	19,0	580	12-1220	69,60 €
21,0	21,4	582	12-1221	111,40 €
21,6	20,1	584	12-1222	111,40 €
23,7	21,1	586	12-1224	111,40 €
24,9	24,8	588	12-1225	158,80 €
26,0	25,3	590	12-1226	158,80 €
26,5	25,4	592	12-1227	158,80 €
27,5	23,9	594	12-1228	158,80 €

Alle Preise zzgl. MWSt., Stand 01/2009
Bitte beachten Sie unsere Rabattstaffeln

Einschraubelemente LAW 1250

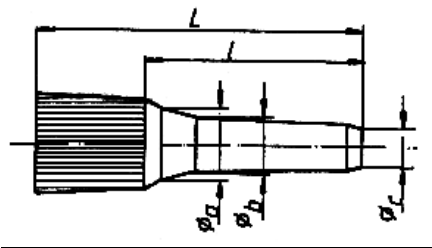

- für kleine Bohrungen
- für Gewindelöcher

Material: PP
Standardfarbe: gelb

für Innen- gewinde	Länge l/mm	Länge L/mm	Durch- messer c/mm	Durch- messer b/mm	Durch- messer a/mm	CO-Nr.	Artikel- Nummer	Preis pro 1000 Stück
M 3	14	20	2,6	3,6	4,0	490	12-1253	41,00 €
M 4	14	20	3,5	4,8	5,0	491	12-1254	47,40 €
M 5	18	25	4,0	5,5	5,8	492	12-1255	55,00 €
M 6	18	25	5,0	6,7	7,0	493	12-1256	62,70 €

Alle Preise zzgl. MWSt., Stand 01/2009
Bitte beachten Sie unsere Rabattstaffeln

Rohrschutzkappen LAW 1300

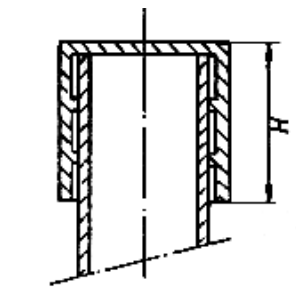

- für Rohre außen
- für glatte Bolzen
- für Außengewinde

Material: PE-weich
Standardfarbe: grau

Rohrdurchmesser in mm	H/mm	CO-Nr.	Artikelnummer	Preis pro 1000 Stück
4,0	10	203	13-4,0	36,80 €
5,0	10	209	13-5,0	36,80 €
6,0	10	211	13-6,0	36,80 €
8,0	10	200	13-8,0	36,80 €
10,0	13	202	13-10,0	36,80 €
10,0	20	204	13-10,0/20	36,80 €
12,0	10	206	13-12,0	36,80 €
13,0	13	207	13-13,0	36,80 €
13,7	13	208	13-13,7	36,80 €
14,0	13	212	13-14,0	36,80 €
14,0	20	210	13-14,0/20	36,80 €
15,0	13	213	13-15,0	38,10 €
16,0	13	215	13-16,0	38,10 €
17,2	13	217	13-17,2	38,10 €
18,0	13	219	13-18,0	47,30 €
19,0	13	220	13-19,0	47,30 €
20,0	20	221	13-20,0	47,30 €
21,3	20	223	13-21,3	61,10 €
22,0	20	225	13-22,0	61,10 €
24,0	20	227	13-24,0	78,90 €
25,0	20	229	13-25,0	93,30 €
26,0	20	230	13-26,0	98,60 €
26,9	20	231	13-26,9	100,00 €
28,0	20	232	13-28,0	100,00 €
30,0	30	233	13-30,0	108,00 €
32,0	30	234	13-32,0	108,00 €
33,7	30	235	13-33,7	109,10 €
35,0	30	237	13-35,0	109,10 €
38,0	30	239	13-38,0	115,50 €

Alle Preise zzgl. MWSt., Stand 01/2009
Bitte beachten Sie unsere Rabattstaffeln

Rohrschutzkappen LAW 1300

40,0	30	241	13-40,0	118,20 €
41,5	30	242	13-41,5	118,20 €
42,4	30	244	13-42,4	120,90 €
44,5	30	246	13-44,5	136,60 €
48,3	30	248	13-48,3	143,20 €
50,0	30	250	13-50,0	150,50 €
51,0	30	252	13-51,0	157,70 €
52,0	30	253	13-52,0	157,70 €
54,0	30	254	13-54,0	176,00 €
57,0	30	256	13-57,0	176,00 €
59,0	30	257	13-59,0	177,30 €
60,3	30	258	13-60,3	177,30 €
63,5	30	260	13-63,5	204,90 €
66,5	30	261	13-66,5	206,20 €
70,0	30	262	13-70,0	236,50 €
73,0	30	264	13-73,0	244,40 €
75,0	30	259	13-75,0	275,80 €
76,0	30	266	13-76,0	275,80 €
77,0	30	268	13-77,0	316,60 €
82,0	30	270	13-82,0	341,50 €
83,0	30	271	13-83,0	341,50 €
85,0	40	272	13-85,0	341,50 €
89,0	40	273	13-89,0	341,50 €
90,0	40	274	13-90,0	384,80 €
95,0	40	275	13-95,0	407,10 €
102,0	40	276	13-102,0	425,50 €
104,0	40	263	13-104,0	499,20 €
108,0	40	277	13-108,0	499,20 €
110,0	40	278	13-110,0	499,20 €
111,0	40	267	13-111,0	499,20 €
114,3	40	280	13-114,3	499,20 €
125,0	40	269	13-125,0	533,20 €
127,0	40	281	13-127,0	533,20 €
133,0	40	282	13-133,0	533,20 €
139,7	40	283	13-139,7	761,70 €
141,3	40	284	13-141,3	761,70 €
151,0	40	279	13-151,0	870,10 €
152,4	40	285	13-152,4	870,10 €
159,0	40	286	13-159,0	939,00 €
160,0	40	287	13-160,0	1.122,90 €
168,3	40	288	13-168,3	1.122,90 €
200,0	40	289	13-200,0	1.262,00 €

Alle Preise zzgl. MWSt., Stand 01/2009
Bitte beachten Sie unsere Rabattstaffeln

Vierkant-Überzugkappen LAW 1350

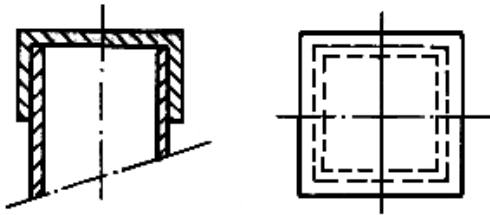

- zum Überstülpen auf Vierkant-Rohren

Material: PE-weich
Standardfarbe: schwarz

Rohrabmessungen außen	CO-Nr.	Artikel- Nummer	Preis pro 1000 Stück
20x20	290	13-2020	132,80 €
25x25	291	13-2525	183,70 €
30x30	294	13-3030	263,90 €
40x40	292	13-4040	388,40 €
50x50	293	13-5050	425,00 €

Alle Preise zzgl. MWSt., Stand 01/2009
Bitte beachten Sie unsere Rabattstaffeln

Vierkantstopfen LAW 1400

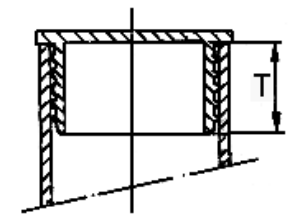

- für Vierkantrohre innen

Material: PE-weich
Standardfarbe: schwarz

quadratisch

Rohr- messungen außen	Wandstärke in mm	Einstecktiefe T/mm	CO-Nr.	Artikel- Nummer	Preis pro 1000 Stück
10x10	1,0-2,0	10,0	1901	14-1010	53,50 €
12x12	1,0-2,0	11,6	1902	14-1212	71,50 €
15x15	1,0-2,0	11,5	1903	14-1515	58,20 €
16x16	1,0-2,0	12,0	1904	14-1616	59,50 €
18x18	1,0-2,0	11,0	1905	14-1818	62,20 €
20x20	1,0-2,0	12,0	1906	14-2020	62,20 €
22x22	1,0-2,0	14,0	1907	14-2222	64,00 €
25x25	1,0-2,0	13,5	1908	14-2525	67,20 €
25x25	3,0	14,0	1909	14-2525-3	80,60 €
27x27	1,0-2,0	15,0	1910	14-2727	133,50 €
30x30	1,0-2,0	13,5	1911	14-3030	79,30 €
30x30	3,0	14,5	1912	14-3030-3	146,90 €
35x35	1,0-2,0	14,5	1914	14-3535	144,50 €
40x40	1,0-2,0	14,0	1915	14-4040	147,20 €
40x40	3,0	14,5	1916	14-4040-3	203,20 €
40x40	5,0	14,5	1917	14-4040-5	319,10 €
50x50	1,5-2,0	19,0	1919	14-5050	291,00 €
50x50	5,0	15,0	1920	14-5050-5	338,20 €
50x50	2,6-5,0	19,0	1924	14-5050-5	291,00 €
60x60	1,0-2,0	19,0	1921	14-6060	419,10 €
60x60	3,0	14,4	1922	14-6060-3	419,10 €
60x60	5,0	15,0	1923	14-6060-5	419,10 €
70x70	2,0-4,0	19,0	1971	14-7070-4	545,80 €
70x70	3,0	17,0	1972	14-7070-3	1.149,20 €
80x80	3,0-4,0	17,0	1973	14-8080-4	670,50 €
90x90	2,0-5,0	25,0	1974	14-9090-2	1.082,80 €
90x90	5,0	18,0	1975	14-9090-5	2.330,00 €
100x100	3,0-6,0	23,0	1976	14-100100-6	1.179,40 €
100x100	5,0	18,0	1977	14-100100-5	2.776,60 €
120x120	2,5-5,0	25,0	1978	14-120120-5	2.891,50 €

Alle Preise zzgl. MWSt., Stand 01/2009
Bitte beachten Sie unsere Rabattstaffeln

Vierkantstopfen LAW 1400

rechteckig

Rohr- messungen außen	Wandstärke in mm	Einstecktiefe T/mm	CO-Nr.	Artikel- Nummer	Preis pro 1000 Stück
20x10	1,5-2,0	11,7	1925	14-2010	76,60 €
20x15	1,0-2,0	11,3	1926	14-2015	77,90 €
25x10	1,0-2,0	11,7	1927	14-2510	79,30 €
25x12	1,5-2,0	10,5	1928	14-2512	79,80 €
25x15	1,0-2,0	11,8	1929	14-2515	83,60 €
25x20	1,0-2,0	14,4	1930	14-2520	90,30 €
30x10	1,0-2,0	12,7	1931	14-3010	68,40 €
30x15	1,5-2,0	12,0	1932	14-3015	79,80 €
30x20	1,5-2,0	14,0	1933	14-3020	76,60 €
30x20	3,0	13,5	1934	14-3020-3	127,90 €
30x25	1,0-2,0	13,6	1935	14-3025	136,70 €
35x10	1,5-2,0	10,1	1936	14-3510	144,80 €
35x20	1,0-2,0	13,0	1937	14-3520	152,10 €
35x25	1,0-2,0	13,5	1938	14-3525	158,50 €
35x30	1,5-2,0	14,5	1939	14-3530	172,30 €
40x10	1,5-2,0	11,0	1940	14-4010	124,70 €
40x15	1,5-2,0	11,7	1941	14-4015	126,70 €
40x20	1,5-2,0	13,9	1942	14-4020	128,00 €
40x20	3,0	13,0	1943	14-4020-3	129,20 €
40x25	1,0-2,0	11,7	1944	14-4025	129,20 €
40x30	1,0-2,0	14,4	1945	14-4030	138,50 €
40x30	3,0	13,0	1946	14-4030-3	138,50 €
45x15	1,0-2,0	11,1	1947	14-4515	150,20 €
45x20	1,0-2,0	12,7	1948	14-4520	169,30 €
45x25	1,5-2,0	12,5	1949	14-4525	178,00 €
48x38	1,0-2,0	14,3	1950	14-4838	224,50 €
50x20	1,0-2,0	13,6	1951	14-5020	138,50 €
50x25	1,5-2,0	12,2	1952	14-5025	148,20 €
50x30	1,0-2,0	13,6	1953	14-5030	161,00 €
50x30	3,0	13,9	1954	14-5030-3	180,60 €
50x40	1,5-2,0	12,0	1955	14-5040	187,30 €
55x35	1,5-2,0	13,2	1956	14-5535	199,20 €
60x20	1,5-2,0	14,2	1957	14-6020	216,70 €
60x25	1,0-2,5	14,1	1958	14-6025	257,90 €
60x30	1,5-2,0	13,7	1959	14-6030	261,30 €
60x40	1,0-2,0	14,0	1960	14-6040	271,20 €
70x25	1,5-2,0	17,0	1961	14-7025	285,40 €
70x30	1,5-2,0	18,0	1962	14-7030	296,00 €
70x40	1,5-2,0	17,7	1963	14-7040	399,50 €
70x40	4,0	17,9	1964	14-7040-4	422,60 €
80x20	1,0-2,0	18,2	1965	14-8020	299,80 €

Alle Preise zzgl. MWSt., Stand 01/2009
Bitte beachten Sie unsere Rabattstaffeln

Vierkantstopfen LAW 1400

rechteckig (Fortsetzung)

Rohr- messungen außen	Wandstärke in mm	Einstecktiefe T/mm	CO-Nr.	Artikel- Nummer	Preis pro 1000 Stück
80x30	1,0-2,0	17,8	1966	14-8030	314,00 €
80x40	1,5-2,5	18,4	1967	14-8040	360,00 €
80x40	4,0	18,1	1980	14-8040-4	1.007,20 €
80x50	2,0-4,0	24,1	1981	14-8050-3	1.042,70 €
80x50	4,0	24,3	1982	14-8050-4	1.047,80 €
80x60	2,5-3,0	24,2	1983	14-8060-3	1.061,70 €
80x60	5,0	18,2	1984	14-8060-5	1.073,20 €
100x40	1,5-2,0	18,6	1985	14-10040-2	1.091,70 €
100x40	3,0-4,0	18,0	1986	14-10040-3	1.094,90 €
100x50	2,0-3,0	24,2	1987	14-10050-3	1.117,70 €
100x50	3,2-6,0	23,6	1988	14-10050-6	1.122,40 €
100x50	5,0	24,5	1989	14-10050-5	1.883,20 €
100x60	2,5-4,5	24,9	1995	14-10060	1.152,90 €
120x30	1,0-2,0	20,1	1968	14-12030	1.178,30 €
120x40	3,0	17,0	1970	14-12040-3	1.276,60 €
120x60	2,0-3,0	24,2	1990	14-12060-2	1.395,20 €
120x60	3,0	18,7	1991	14-12060-3	2.174,30 €
120x60	4,0	18,0	1992	14-12060-4	2.174,30 €
120x60	5,0	17,5	1993	14-12060-5	2.174,30 €

Alle Preise zzgl. MWSt., Stand 01/2009
Bitte beachten Sie unsere Rabattstaffeln

Lamellenstopfen LAW 1450

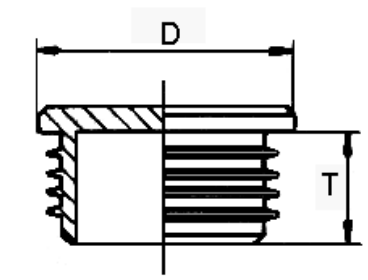

- für Rohre innen
- für glatte Bohrungen
- für Innengewinde

Material: PE-weich
Standardfarbe: schwarz

D/mm	T/mm	für Rohre mit Wand- stärke von - bis mm	CO-Nr.	Artikel- Nummer	Preis pro 1000 Stück
12	10,0	1,0-1,5	302	14-1452	43,80
13	10,0	1,0-2,0	304	14-1454	43,80
14	9,3	1,0-2,0	306	14-1456	43,80
15	9,6	1,0-2,0	308	14-1458	43,80
16	10,0	1,0-2,0	310	14-1460	56,70
18	12,0	1,0-2,0	312	14-1462	56,70
19	11,0	1,0-2,0	314	14-1464	56,70
20	12,0	1,0-2,0	316	14-1466	56,70
22	11,8	1,0-2,0	318	14-1468	56,70
25	11,8	1,0-2,0	320	14-1470	62,40
25	11,8	2,0-3,0	322	14-1472	99,80
27	13,8	1,0-2,5	324	14-1474	86,80
28	14,0	1,0-2,0	326	14-1476	86,80
30	14,0	1,0-2,0	328	14-1478	115,80
30	14,0	2,0-3,0	330	14-1480	126,20
32	14,5	1,0-2,0	332	14-1482	145,50
32	14,0	2,0-3,0	334	14-1484	180,20
34	14,5	1,0-2,0	336	14-1486	164,80
35	14,3	1,0-2,0	329	14-1487	164,80
36	13,8	1,0-2,0	338	14-1488	164,80
38	11,8	1,0-2,0	340	14-1490	207,10
40	11,7	1,0-2,0	342	14-1492	207,10
42	11,5	1,0-2,0	344	14-1494	207,10
45	15,0	1,0-2,0	346	14-1496	231,10
48	18,0	1,5-2,5	331	14-1496a	245,10
48	17,8	3,0-4,0	333	14-1496b	245,10
50	16,0	1,5-2,5	327	14-1498	229,10
50	17,5	2,5-3,5	315	14-1499a	229,10
51	15,8	2,0-3,5	348	14-1496c	229,10
55	13,7	1,0-2,0	335	14-1498a	236,80
60	21,4	1,5-2,5	337	14-1498b	258,70
60	21,3	3,0-4,0	339	14-1498c	264,40

Alle Preise zzgl. MWSt., Stand 01/2009
Bitte beachten Sie unsere Rabattstaffeln

Lamellenstopfen LAW 1450

D/mm	T/mm	für Rohre mit Wand- stärke von - bis mm	CO-Nr.	Artikel- Nummer	Preis pro 1000 Stück
70	21,0	2,0-4,5	341	14-1498d	278,00
76	21,5	1,5-2,5	343	14-1498e	311,40
76	22,0	3,0-4,0	345	14-1498f	311,40
80	17,5	1,5-2,0	313	14-1499b	378,30
90	20,0	2,5-5,0	347	14-1498g	562,90
102	20,0	2,0-4,0	349	14-1498h	544,20

Alle Preise zzgl. MWSt., Stand 01/2009
Bitte beachten Sie unsere Rabattstaffeln

Lamellenstopfen LAW 1460

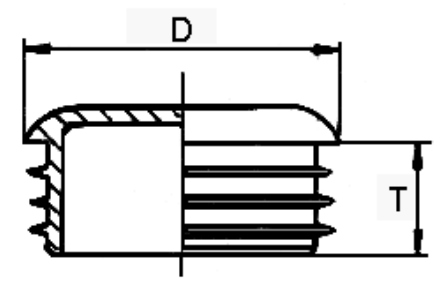

- für Rohre innen
- für glatte Bohrungen
- für Innengewinde

Material: PE-weich
Standardfarbe: schwarz

D/mm	T/mm	für Wandstärken von - bis mm	CO-Nr.	Artikel- Nummer	Preis pro 1000 Stück
12,1	10,0	1,0-2,0	1402	14-1452-R	41,80 €
12,9	10,0	1,0-2,0	1404	14-1454-R	41,80 €
14,0	9,5	1,0-2,0	1406	14-1456-R	41,80 €
15,0	9,0	1,0-2,0	1408	14-1458-R	41,80 €
15,9	9,0	1,0-2,0	1410	14-1460-R	54,00 €
18,1	12,0	1,0-2,0	1412	14-1462-R	54,00 €
19,0	11,2	1,0-2,0	1414	14-1464-R	54,00 €
20,0	11,8	1,0-2,0	1416	14-1466-R	54,00 €
22,0	11,8	1,0-2,0	1418	14-1468-R	54,00 €
25,0	12,0	1,0-2,0	1420	14-1470-R	59,50 €
24,9	11,8	1,0-2,0	1422	14-1472-R	106,50 €
24,9	11,8	3,0	1424	14-1474-R	106,50 €
27,0	13,8	1,0-2,0	1426	14-1476-R	108,30 €
28,0	14,0	1,0-2,0	1428	14-1478-R	108,30 €
30,1	14,0	1,0-2,0	1430	14-1480-R	110,30 €
32,1	14,6	1,0-2,0	1432	14-1482-R	138,50 €
34,0	14,5	1,0-2,0	1436	14-1486-R	156,90 €
35,0	14,0	1,0-2,0	1438	14-1488-R	156,90 €
35,8	13,9	1,0-2,0	1440	14-1490-R	156,90 €
37,9	11,5	1,0-2,0	1442	14-1492-R	197,30 €

Alle Preise zzgl. MWSt., Stand 01/2009
Bitte beachten Sie unsere Rabattstaffeln

Endkappen LAW 1500

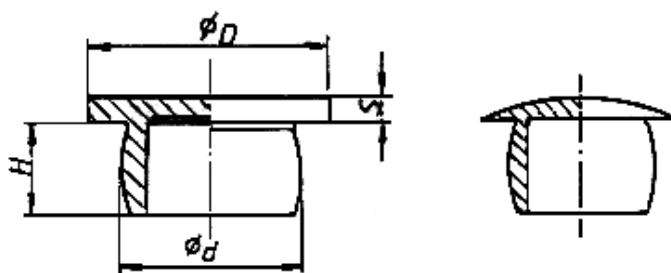

- für Rohre innen
- für glatte Bohrungen
- für Innengewinde

Material: PE-weich
Standardfarbe: creme

d/mm	D/mm	H/mm	S/mm	Kopfform flach		Kopfform rund		Preis pro 1000 Stück
				CO-Nr.	Artikel-Nummer	CO-Nr.	Artikel-Nummer	
7,20	12	6	2	600	15-15073A	650	15-15073B	32,00 €
8,40	12	6	2	602	15-15085A	652	15-15085B	32,00 €
9,25	12	6	2	604	15-15093A	654	15-15093B	32,00 €
10,70	14	6	2	606	15-15107A	656	15-15107B	32,00 €
11,80	16	8	2	608	15-15118A	658	15-15118B	32,00 €
12,50	16	8	2	610	15-15125A	660	15-15125B	32,00 €
13,70	16	8	2	613	15-15137A	663	15-15137B	32,00 €
14,30	16	8	2	609	15-15143A	661	15-15143B	32,00 €
14,80	20	8	2	612	15-15147A	662	15-15147B	32,00 €
15,80	20	8	2	614	15-15158A	664	15-15158B	37,20 €
17,30	22	8	2	616	15-15173A	666	15-15173B	37,20 €
19,50	25	8	2	618	15-15195A	668	15-15195B	37,20 €
20,50	25	8	2	619	15-15205A	671	15-15205B	39,70 €
21,50	25	8	2	620	15-15215A	670	15-15215B	39,70 €
22,20	25	8	2	622	15-15225A	672	15-15225B	39,70 €
24,30	30	10	3	624	15-15242A	674	15-15242B	39,70 €
26,50	30	10	3	626	15-15265A	676	15-15265B	39,70 €
29,70	36	12	3	628	15-15300A	678	15-15300B	71,60 €
32,10	36	12	3	630	15-15320A	680	15-15320B	71,60 €
35,70	42	16	3	631	15-15355A	681	15-15355B	76,80 €
36,00	43	11	3	635	15-15360A	679	15-15360B	99,80 €
37,30	43	16	3	632	15-15370A	682	15-15370B	99,80 €
37,70	43	16	3	633	15-15380A	683	15-15380B	99,80 €
39,20	43	16	3	634	15-15390A	684	15-15390B	111,30 €
40,10	46	36	3	636	15-15400A	686	15-15400B	120,20 €
41,40	43	16	3	637	15-15410A	687	15-15410B	125,40 €
46,50	52	16	3	638	15-15460A	688	15-15460B	125,40 €
55,30	64	18	3	640	15-15550A			158,60 €
61,00	64	18	3	642	15-15610A			235,20 €
81,40	88	18	3	644	15-15810A			409,00 €
91,20	97	18	3	646	15-15910A			476,10 €
101,40	108	18	3	647	15-151010A			613,50 €
121,30	133	18	3	648	15-151210A			760,50 €

Alle Preise zzgl. MWSt., Stand 01/2009
Bitte beachten Sie unsere Rabattstaffeln

Endkappen LAW 1500

Anwendungen

Regelgewinde DIN 13	Artikelnummer	Artikelnummer
M 8	15-15073A	15-15073B
M 10	15-15093A	15-15093B
M 12	15-15107A	15-15107B
M 14	15-15118A	15-15118B
M 16	15-15147A	15-15147B
M 18	15-15158A	15-15158B
M 20	15-15173A	15-15173B
M 24	15-15215A	15-15215B
M 27	15-15242A	15-15242B
M 30	15-15265A	15-15265B
M 33	15-15300A	15-15300B
M 36	15-15320A	15-15320B
M 42	15-15390A	15-15390B

Endkappen LAW 1510

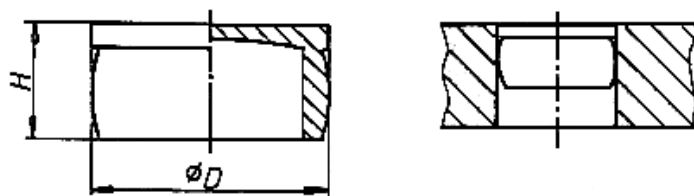

- für Rohre innen
- für glatte Bohrungen
- für Innen-gewinde

Material: PE-weich
Standardfarbe: creme

D/mm	H/mm	CO-Nr.	Artikel- Nummer	Preis pro 1000 Stück
7,20	8	1302	15-15073C	32,00 €
8,40	8	1304	15-15085C	32,00 €
9,25	8	1306	15-15093C	32,00 €
10,70	8	657	15-15107C	32,00 €
11,80	10	1310	15-15118C	32,00 €
12,50	10	1312	15-15125C	32,00 €
13,70	10	1314	15-15137C	32,00 €
14,30	10	1316	15-15143C	32,00 €
14,80	10	1318	15-15147C	32,00 €
15,80	10	1320	15-15158C	37,20 €
17,30	10	667	15-15173C	37,20 €
19,50	10	1324	15-15195C	37,20 €
20,50	10	1326	15-15205C	39,70 €
21,50	10	1328	15-15215C	39,70 €
22,20	10	1330	15-15225C	39,70 €
24,30	13	1332	15-15242C	39,70 €
26,50	13	1334	15-15265C	39,70 €
29,70	15	1336	15-15300C	71,60 €
32,10	15	1338	15-15320C	71,60 €
35,70	19	1340	15-15355C	76,80 €
36,00	15	1342	15-15360C	99,80 €
37,30	19	1344	15-15370C	99,80 €
37,70	19	1346	15-15380C	99,80 €
39,20	19	1348	15-15390C	111,30 €
40,10	19	1350	15-15400C	120,20 €

Alle Preise zzgl. MWSt., Stand 01/2009
Bitte beachten Sie unsere Rabattstaffeln

Stopfen LAW 1600

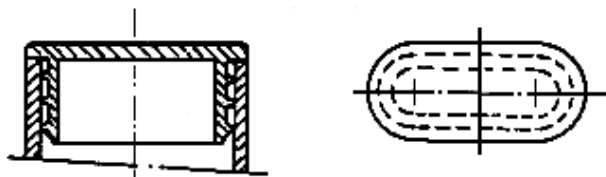

- für Ovalrohre innen

Material: PE-weich
Standardfarbe: schwarz

für Rohre in mm	für Wandstärke in mm	CO-Nr.	Artikel- Nummer	Preis pro 1000 Stück
20x10	1,5-2,0	1602	16-1602	110,90 €
25x12	2,0	1604	16-1604	110,90 €
30x15	1,0-2,0	1606	16-1606	112,20 €
30x15	1,5-2,5	1608	16-1608	112,20 €
35x15	1,2x2,5	1610	16-1610	112,20 €
35x20	1,0-2,0	1612	16-1612	112,20 €
38x20	1,0-2,0	1614	16-1614	125,10 €
40x20	1,0-2,0	1616	16-1616	125,10 €
40x20	2,5	1618	16-1618	125,10 €
48x20	1,0-3,0	1620	16-1620	161,80 €
50x20	1,0-2,0	1622	16-1622	161,80 €
60x20	1,0-2,0	1624	16-1624	201,20 €
60x30	1,0-2,0	1626	16-1626	275,10 €

Alle Preise zzgl. MWSt., Stand 01/2009
Bitte beachten Sie unsere Rabattstaffeln

Stopfen mit Griffband LAW 1700

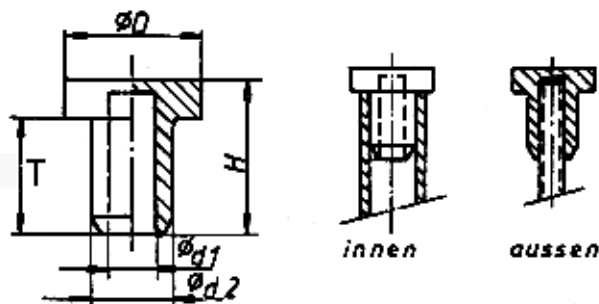

- für Rohre innen
- für Rohre außen
- für glatte Bohrungen

Material: PP
Standardfarbe: creme

d1/mm	d2/mm	D/mm	T/mm	H/mm	CO-Nr.	Artikel- Nummer	Preis pro 1000 Stück
4,2	6,2	12	12	16	1700	17-1700	46,10 €
5,3	7,3	13	12	16	1702	17-1702	46,10 €
5,4	8,4	14	12	16	1704	17-1704	46,10 €
7,0	9,3	15	15	19	1706	17-1706	46,10 €
7,7	10,7	16	15	19	1708	17-1708	46,10 €
8,8	11,6	17	16	20	1710	17-1710	46,10 €
9,7	12,5	18	18	23	1712	17-1712	49,90 €
10,7	14,6	19	20	24	1714	17-1714	49,90 €
11,6	15,7	20	20	24	1716	17-1716	53,80 €
13,4	17,2	22	20	24	1718	17-1718	53,80 €
13,4	19,1	24	20	24	1720	17-1720	66,50 €
15,5	21,2	26	20	24	1722	17-1722	92,70 €
17,1	21,5	26	20	24	1724	17-1724	92,70 €
17,5	22,5	27	20	24	1726	17-1726	103,50 €
19,3	23,8	29	20	24	1728	17-1728	103,50 €
21,1	24,6	29	20	24	1730	17-1730	103,50 €
21,4	25,5	30	20	24	1732	17-1732	117,60 €
21,4	26,4	39	20	24	1734	17-1734	117,60 €
23,4	28,8	34	20	24	1736	17-1736	166,20 €
26,9	30,3	34	20	24	1738	17-1738	166,20 €

Alle Preise zzgl. MWSt., Stand 01/2009
Bitte beachten Sie unsere Rabattstaffeln

Stopfen mit Griffband LAW 1700

Anwendung innen

Reihe 1	Reihe 2	Reihe 3	Reihe 4	Artikelnummer
M 8			M 8	17-1702
M 10				17-1704
			M 10 x 1	17-1706
M 12			M 12 x 1,5	17-1708
M 14		M 12 x 1		17-1710
			M 14 x 1,5	17-1712
M 16			M 16 x 1,5	17-1714
M 18				17-1716
M 22				17-1720
M 24			M 22 x 1,5	17-1722
	M 24 x 2			17-1724
			M 24 x 1,5	17-1726
M 27				17-1728
M 30			M 26 x 1,5	17-1730
	M 27 x 2		M 27 x 1,5	17-1732
M 30			M 28 x 1,5	17-1734
	M 30 x 2		M 30 x 1,5	17-1736
M 33			M 30 x 1,5	17-1738

Anwendung außen

Durchmesser Gewinde metrisch	Artikelnummer
M 6	17-1704
M 8	17-1708
M 10	17-1712
M 12	17-1716
M 14	17-1718
	17-1720
M 16	17-1722
	17-1724
M 18	17-1726
M 20	17-1728
	17-1730
M 22	17-1734
M 24	17-1736
M 27	17-1738

Schraubstopfen LAW 1800

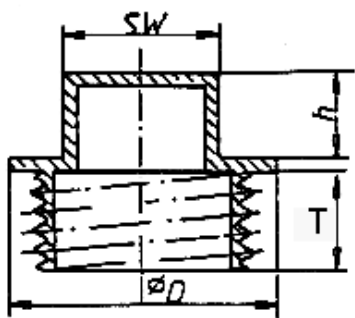

- für Innengewinde

Material: PA
Standardfarbe: natur

D/mm	T/mm	h/mm	SW	CO-Nr.	Artikel- Nummer	Preis pro VPE
13	7	6	9	1801	18-1801	123,00 €
16	7	6	11	1803	18-1803	133,80 €
21	8	7	12	1805	18-1805	158,30 €
27	9	8	14	1807	18-1807	187,60 €
34	11	8	17	1809	18-1809	211,70 €
41	11	8	19	1811	18-1811	344,70 €
53	11	8	24	1813	18-1813	413,30 €

Alle Preise zzgl. MWSt., Stand 01/2009
Bitte beachten Sie unsere Rabattstaffeln

Stopfen zylindrisch LAW 1850

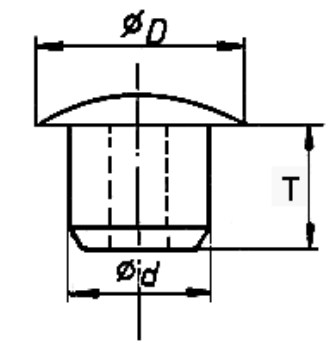

- für Bohrungen
- für Innengewinde

Material: PE

Standardfarbe: weiß und schwarz

d/mm	D/mm	T/mm	für Gewinde	CO-Nr.	Artikel- Nummer weiß	CO-Nr.	Artikel- Nummer schwarz	Preis pro 1000 Stück
2,8	11,0	4,8	M 5	1815	18-1850w	1850	18-1850s	25,80 €
4,0	8,0	3,0		1816	18-1851w	1851	18-1851s	25,80 €
4,0	13,0	5,3		1817	18-1852w	1852	18-1852s	26,50 €
5,4	8,0	7,4	M 6	1818	18-1853w	1853	18-1853s	25,80 €
6,0	10,0	5,4		1819	18-1854w	1854	18-1854s	25,80 €
6,0	13,0	5,4		1820	18-1855w	1855	18-1855s	26,50 €
6,0	15,0	5,4		1821	18-1856w	1856	18-1856s	43,80 €
6,5	15,0	6,0		1822	18-1859w	1859	18-1859s	43,80 €
7,0	16,0	6,5	M 8	1823	18-1860w	1860	18-1860s	43,80 €
8,0	13,0	6,3		1824	18-1861w	1861	18-1861s	26,50 €
8,0	16,0	6,3		1825	18-1862w	1862	18-1862s	28,40 €
8,5	13,0	6,9		1826	18-1863w	1863	18-1863s	38,00 €
9,0	13,0	6,4	M 10	1827	18-1865w	1865	18-1865s	38,00 €
10,0	13,0	6,7		1828	18-1866w	1866	18-1866s	38,00 €
10,0	16,0	6,7		1829	18-1867w	1867	18-1867s	38,00 €
10,5	13,0	4,0		1830	18-1867Aw	1890	18-1867As	30,90 €
11,0	15,0	5,0	M 12x1,5	1831	18-1868w	1868	18-1868s	43,80 €
12,0	18,0	8,4		1832	18-1869w	1869	18-1869s	108,10 €
14,0	18,0	7,0		1833	18-1870w	1870	18-1870s	131,90 €
15,0	17,0	9,0		1834	18-1871w	1871	18-1871s	131,90 €
15,0	20,0	4,0		1835	18-1869Aw	1891	18-1869As	135,20 €
17,0	24,5	6,0		1836	18-1872w	1872	18-1872s	138,40 €
20,0	23,0	10,0		1837	18-1873w	1873	18-1873s	164,00 €
25,0	30,0	5,0		1838	18-1874w	1874	18-1874s	167,30 €

Alle Preise zzgl. MWSt., Stand 05/2009
Bitte beachten Sie unsere Rabattstaffeln

Senkstopfen mit Rändel LAW 2000

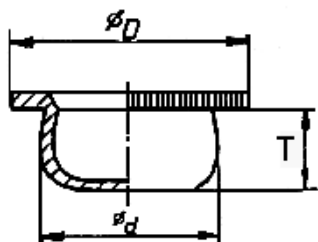

- für Bohrungen
- für Gewinde

Material: PE-weich
Standardfarbe: natur

d/mm	D/mm	T/mm	ISO DIN 13 Regel- gewinde	ISO DIN 13 Feingewinde	CO-Nr.	Artikel- Nummer	Preis pro 1000 Stück
2,5	7,0	4,0	M 3		350	20-2025	39,00 €
3,0	7,0	6,5			351	20-2030	39,00 €
3,2	7,0	6,5	M 4		352	20-2032	39,00 €
3,5	7,5	4,0	M 4	M 4x0,5	353	20-2035	40,60 €
4,0	9,0	3,5			354	20-2040	40,70 €
4,5	7,0	4,5	M 5	M 5x0,5	356	20-2045	41,60 €
5,0	12,0	7,5			357	20-2050	54,20 €
5,3	9,0	6,0	M 6	M 6x0,75	358	20-2052	47,00 €
6,1	10,5	6,0		M 6x0,5	359	20-2060	54,20 €
6,6	10,5	7,0	M 7		360	20-2065	54,20 €
6,9	10,5	7,0	M 8		362	20-2069	54,20 €
7,6	11,5	7,0		M 8x1-0,75	363	20-2075	60,50 €
8,0	12,5	7,5			364	20-2080	60,50 €
8,5	13,0	6,5	M 10	M 10x1,25-0,75	365	20-2085	60,50 €
9,2	13,0	7,0			366	20-2090	62,40 €
9,6	13,0	7,0			368	20-2095	62,40 €
10,6	15,5	7,0	M 12	M 12x1,25-1,0	369	20-2105	62,40 €
11,1	15,5	7,0		M 12x1,25-1,0	370	20-2111	62,40 €
12,3	16,0	7,0	M 14		371	20-2125	62,40 €
13,2	17,5	7,0		M 14x1,25-1,0	372	20-2130	64,80 €
14,0	18,0	7,5	M 16		374	20-2140	64,80 €
14,7	20,0	7,0	M 16	M 14x1,5-1,0	375	20-2145	64,80 €
15,9	20,0	7,0	M 18	M 16x1 M 18x2	376	20-2159	64,80 €
16,5	22,0	7,0		M 18x1,5	377	20-2165	64,80 €
17,5	23,0	7,0	M 20	M 20x2-1,5	378	20-2175	74,80 €
19,0	25,0	7,0		M 20x1,5	380	20-2190	82,70 €
20,0	25,0	7,0	M 22	M20x1,5 M22,2	381	20-2200	82,70 €
21,0	25,0	7,0	M 22	M 22x2-1,5	382	20-2210	82,70 €
23,5	28,0	7,5	M 24	M 24x2	383	20-2235	108,40 €
25,0	31,0	7,0	M 27	M 27x2	384	20-2250	108,40 €
26,0	31,0	7,5		M 27x1,5	386	20-2260	135,20 €
28,2	35,0	7,0	M 30	M 30x3	387	20-2285	135,20 €
31,0	37,0	7,0	M 33	M 33x1	388	20-2310	135,20 €
32,8	37,0	7,0	M 36		389	20-2330	135,20 €

Alle Preise zzgl. MWSt., Stand 01/2009
Bitte beachten Sie unsere Rabattstaffeln

Schutzhülsen LAW 2100

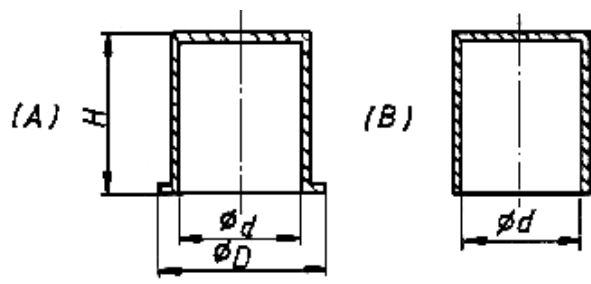

- für lange Wellenenden
- für Gewinde und Rohre außen

Material: PE-weich
Standardfarbe: creme

mit Bund (A)

d/mm	D/mm	H/mm	CO-Nr.	Artikel-Nummer	Preis pro 1000 Stück
5,0	9	20	806	21-56520 A	44,70 €
8,0	13	30	814	21-89530 A	69,00 €
10,0	15	20	817	21-101120 A	48,70 €
12,0	17	20	821	21-121320 A	55,00 €
12,0	17	50	820	21-121350 A	156,60 €
20,0	26	70	852	21-202270 A	409,00 €
25,0	31	50	860	21-252750 A	248,10 €
27,0	34	50	864	21-272950 A	248,10 €
29,0	34	70	865	21-293270 A	457,00 €
30,0	37	50	870	21-303250 A	268,40 €
30,0	37	70	872	21-303270 A	460,20 €
35,0	42	100	880	21-3537100 A	536,90 €
42,0	45	100	889	21-4244100 A	856,30 €
48,0	52	60	891	21-485060 A	538,10 €

Alle Preise zzgl. MWSt., Stand 01/2009
bitte beachten Sie unsere Rabattstaffeln

Schutzhülsen lang LAW 2100

ohne Bund (B)

d/mm	H/mm	CO-Nr.	Artikel- Nummer	Preis pro 1000 Stück
4,0	10	900	21-45511 B	30,70 €
4,0	20	902	21-45521 B	46,10 €
5,0	10	904	21-56511 B	30,70 €
6,0	10	908	21-67511 B	30,70 €
6,0	20	909	21-67521 B	46,10 €
8,0	10	912	21-89511 B	34,50 €
8,0	20	913	21-89521 B	48,70 €
10,0	10	916	21-101111 B	34,50 €
10,0	20	917	21-101121 B	48,70 €
10,0	40	919	21-101141 B	75,50 €
12,0	10	920	21-121311 B	46,10 €
12,0	20	922	21-121321 B	55,00 €
12,0	40	923	21-121341 B	90,80 €
12,0	50	924	21-121351 B	156,60 €
14,0	20	928	21-141521 B	60,10 €
14,0	30	929	21-141531 B	81,90 €
14,0	50	931	21-141551 B	137,40 €
15,0	40	936	21-151641 B	107,30 €
15,0	60	938	21-151661 B	248,10 €
16,0	30	942	21-161831 B	98,40 €
18,0	30	946	21-182031 B	113,80 €
20,0	40	950	21-202241 B	136,70 €
20,0	70	952	21-202271 B	409,00 €
22,0	40	953	21-222441 B	202,00 €
24,0	40	956	21-242641 B	202,00 €
25,0	50	960	21-252751 B	248,10 €
27,0	50	964	21-272951 B	248,10 €
27,0	80	966	21-272981 B	536,90 €
30,0	50	970	21-303251 B	268,40 €
30,0	87	971	21-303387 B	686,30 €
33,0	50	974	21-333551 B	281,30 €
33,0	80	976	21-333581 B	646,70 €
35,0	80	979	21-353781 B	646,70 €
40,0	60	983	21-404261 B	536,90 €
40,0	100	985	21-4042101 B	856,30 €
42,0	60	987	21-424461 B	536,90 €
42,0	100	989	21-4244101 B	856,30 €
45,0	70	990	21-454871 B	549,60 €
48,0	60	991	21-485061 B	513,70 €
49,0	100	992	21-4952101 B	901,00 €
50,0	60	993	21-505261 B	549,60 €
50,0	100	996	21-5052101 B	952,20 €
60,0	135	998	21-6065135 B	1.329,20 €

Alle Preise zzgl. MWSt., Stand 01/2008; bitte beachten Sie unsere Rabattstaffeln

Kappen für Schmiernippel LAW 2150

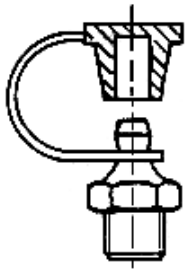

- Abdeckung für Schmiernippel

Material: PE-weich
Standardfarbe: rot

CO-Nr.	Artikel- Nummer	Preis pro 1000 Stück
460	21-2150	52,50 €

Alle Preise zzgl. MWSt., Stand 01/2009
Bitte beachten Sie unsere Rabattstaffeln

Kappen gewölbt für Sechskantmuttern LAW 2200

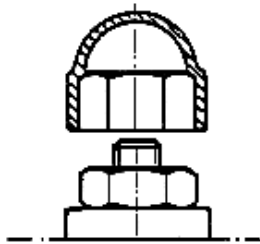

- Abdeckung für Sechskantmuttern
934, 936, 439, 555

DIN

Material: PE-weich
Standardfarbe: schwarz

Regel- gewinde	Fein- gewinde	SW	CO- Nr.	Artikel- Nummer schwarz	Preis pro 1000 Stück
M 4		7	470	22-2204s	44,70 €
M 5		8	472	22-2205s	44,70 €
M 6		10	474	22-2206s	51,20 €
M 8	M 8x1	13	476	22-2208s	51,20 €
M 10	M 10x1	17	478	22-2210s	83,10 €
M 12	M 12x1,5	19	480	22-2212s	90,80 €
M 16	M 16x1,5	24	482	22-2216s	117,60 €

Alle Preise zzgl. MWSt., Stand 01/2009
Bitte beachten Sie unsere Rabattstaffeln

Kappen flach für Sechskant LAW 2250

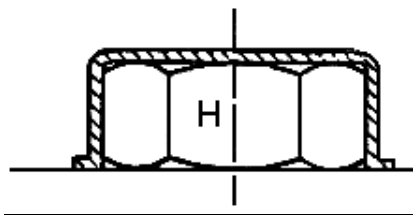

- für Sechskantmuttern

Material: PE-weich
Standardfarbe: creme

Schlüssel- weite	Gewinde	H/mm	CO-Nr.	Artikel-Nummer	Preis pro 1000 Stück
10	M 6	10,0	190	2250-M 6	46,10 €
13	M 8	10,0	191	2250-M 8	49,90 €
16	M 10	10,0	193	2250-M 10	53,80 €
18	M 12	10,0	194	2250-M 12	55,00 €
24	M 16	16,0	196	2250-M 16	65,20 €

Alle Preise zzgl. MWSt., Stand 01/2009
Bitte beachten Sie unsere Rabattstaffeln

Klemmkappen Sechskant LAW 2260

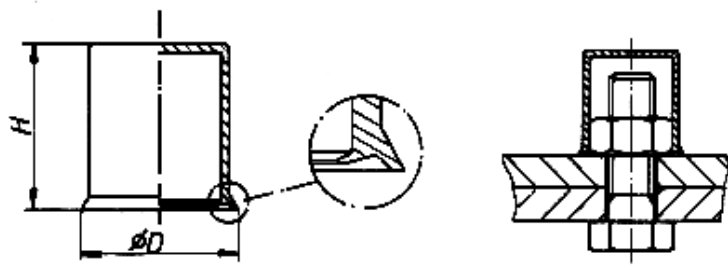

- für Sechskantmuttern

Material: PE-weich
Standardfarbe: creme

Schlüssel- weite	Gewinde	Gewinde	H/mm	D/mm	CO-Nr.	Artikel- Nummer	Preis pro 1000 Stück
8	M 5		11,0	12	1452	2260-M 5	34,50 €
10	M 6		14,0	15	1454	2260-M 6	37,20 €
13	M 8	M 8x1	19,0	19	1456	2260-M 8	52,50 €
17	M 10	M 10x1	25,5	24	1458	2260-M 10	81,90 €
19	M 12	M 12x1,5	29,0	27	1460	2260-M 12	112,50 €
22	M 14	M 14x1,5	34,0	30	1462	2260-M 14	120,20 €
24	M 16	M 16x1,5	38,0	33	1464	2260-M 16	124,00 €
30	M 20	M 20x1,5	48,0	42	1466	2260-M 20	156,60 €

alle Preise zzgl. MWSt., Stand 01/2009
Bitte beachten Sie unsere Rabattstaffeln

Distanzscheiben LAW 2300

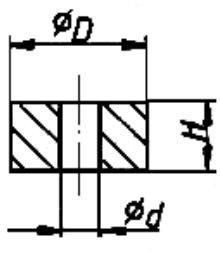

- als Abstandhalter
- als Dämpfungselement

Material: PE-weich
Standardfarbe: schwarz

D/mm	d/mm	H/mm	CO-Nr.	Artikel- Nummer	Preis pro 1000 Stück
15,0	4,0	6,0	412	D23-6154	48,80 €
15,0	5,1	6,0	414	D23-6155	48,80 €
15,0	5,0	8,0	418	D23-8155	55,50 €
15,0	6,1	6,0	416	D23-6156	48,80 €
15,0	6,2	8,0	420	D23-8156	55,50 €
15,0	7,2	2,0	400	D23-2157	55,50 €
15,0	7,0	5,0	406	D23-5157	55,50 €
15,0	7,0	14,0	434	D23-14157	59,70 €
20,0	6,3	10,0	424	D23-10206	68,50 €
20,0	10,5	5,0	408	D23-52010	68,50 €
22,0	6,0	10,0	426	D23-10226	74,50 €
22,0	7,0	3,0	402	D23-3227	108,90 €
25,0	6,0	5,0	410	D23-5256	119,60 €
25,0	6,1	10,0	428	D23-10256	165,50 €
32,0	7,1	3,0	404	D23-3327	165,50 €
40,0	5,5	10,0	430	D23-10405	277,00 €
40,0	10,5	10,0	432	D23-104010	277,00 €

Alle Preise zzgl. MWSt., Stand 01/2009
Bitte beachten Sie unsere Rabattstaffeln

Kappen für Inbusschrauben LAW 2400

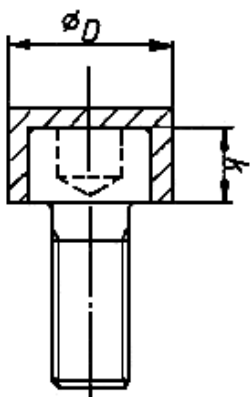

- über den runden Kopf geschoben wie Rohrschutzkappen für DIN 912

Material: PE-weich
Standardfarbe: creme

Bedingt auch für DIN 7984 einsetzbar

M 5	11,5	5,3	1202	24-M 5	29,40 €
M 6	13,0	6,3	1205	24-M 6	29,40 €
M 8	16,0	8,5	1208	24-M 8	33,30 €
M 10	19,0	10,8	1211	24-M 10	33,30 €
M 12	21,0	13,0	1214	24-M 12	35,80 €
M 16	27,0	17,0	1217	24-M 16	35,80 €

Alle Preise zzgl. MWSt., Stand 01/2009
Bitte beachten Sie unsere Rabattstaffeln

Kappen für Inbusschrauben LAW 2500

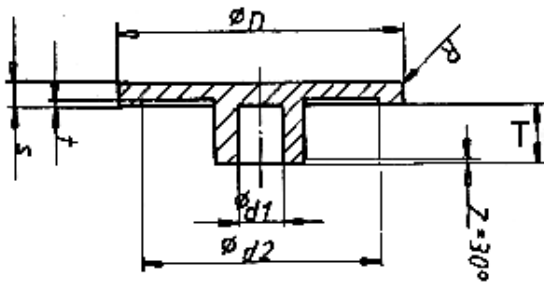

- zum Verschließen, Markieren, Sichern

Material: ABS
Standardfarbe: schwarz

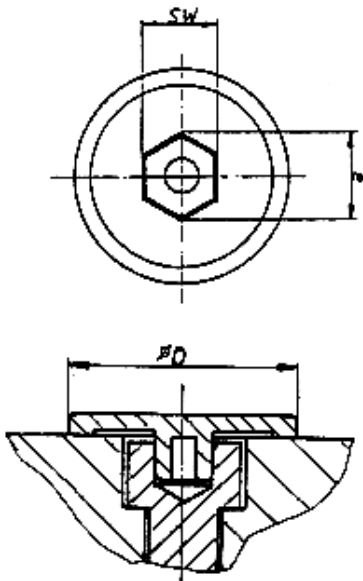

Die Kappen werden in den Sechskant eingedrückt und verklemmen sich

Maßtabelle

M	SW	D/mm	d1/mm	d2/mm	t/mm	s/mm	T/mm	R/mm	e/mm	z/mm
5	4	15	1,5	11	0,5	2	2,9	0,5	4,4	0,3
6	5	19	2,0	16	0,5	1	3,0	0,5	5,6	0,3
8	6	25	3,8	21	0,5	2	3,7	0,5	6,7	0,5
10	8	25	5,7	21	0,5	2	4,0	0,5	9,0	0,5
12	10	30	7,7	26	0,5	2	4,5	0,5	11,3	0,5
16	14	35	11,7	31	0,5	2	6,1	0,5	16,0	0,5

Kappen für Inbusschrauben LAW 2500

Gewinde	CO-Nr.	Artikel-Nummer	Preis pro 1000 Stück
M 5	1240	25-M 5	35,50 €
M 6	1243	25-M 6	35,50 €
M 8	1246	25-M 8	39,30 €
M 10	1249	25-M 10	39,30 €
M 12	1252	25-M 12	53,10 €
M 16	1255	25 M 16	53,10 €

Alle Preise zzgl. MWSt., Stand 01/2009
Bitte beachten Sie unsere Rabattstaffeln

Zierkappen für Inbusschrauben LAW 2600

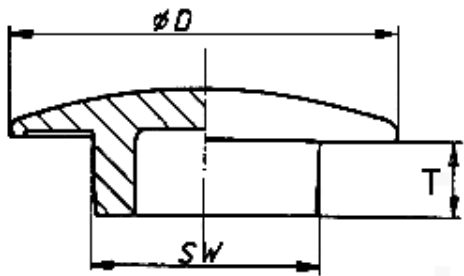

- zum Abdecken von Inbusschrauben

Material: ABS
Standardfarbe: schwarz

Gewinde	D/mm	T/mm	SW/mm	CO-Nr.	Artikel-Nummer	Preis pro 1000 Stück
M 6	10	3,0	5	1260	26-M 6	29,20
M 8	13	3,7	6	1263	26-M 8	33,00
M 10	16	4,0	8	1266	26-M 10	33,00
M 12	18	4,6	10	1269	26-M 12	35,50

Die Kappen werden in den Sechskant eingedrückt und verkleben sich

Alle Preise zzgl. MWSt., Stand 01/2009
Bitte beachten Sie unsere Rabattstaffeln

Kunststoffverarbeitung und Fertigung von Baugruppen

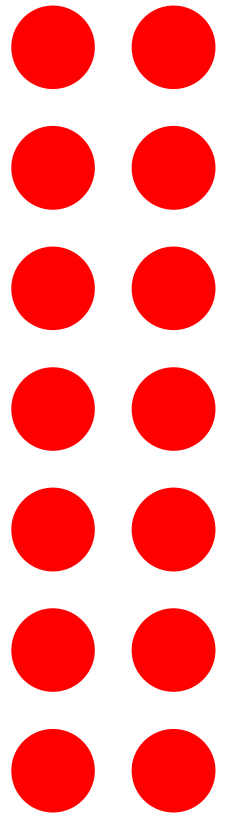

LAWAL Kunststoffe GmbH

Raiffeisenstrasse 4

89129 Langenau

Telefon (0 73 45) 91 27-0

Telefax (0 73 45) 91 27-29

<http://www.lawal.de>

e-Mail: schutzelemente@lawal.de